

ELECTROLINE

Cat.# E-L 278

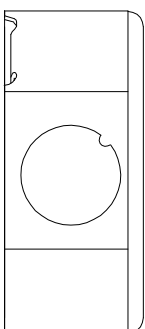
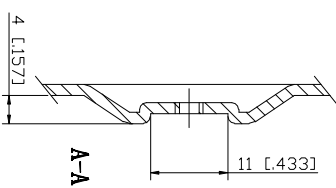
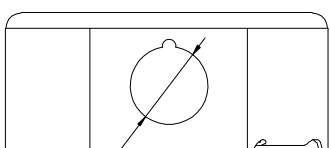
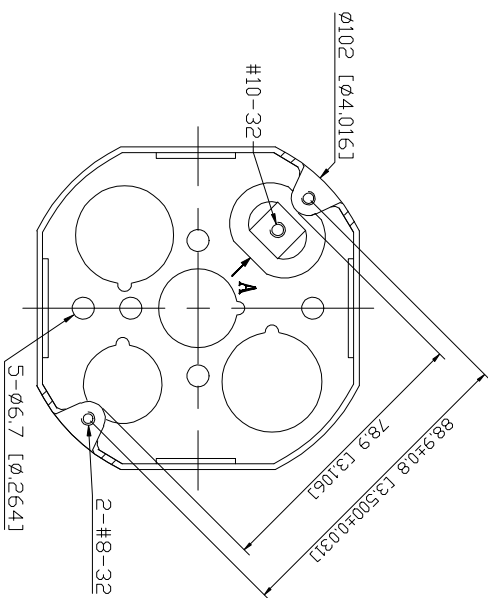
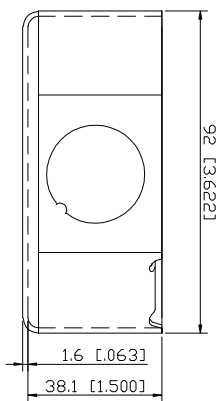
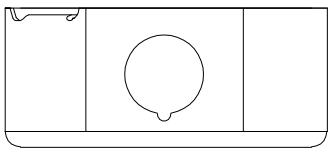
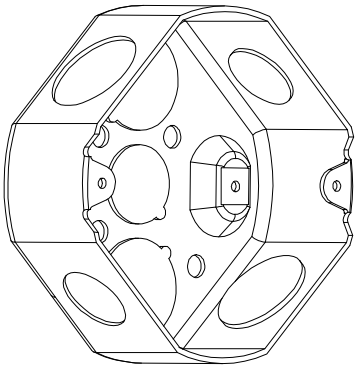

4×4×1-1/2"
 (4" B-1/2" & 3/4")
 1.6mm