

# ELECTROLINE

## Cat.# E-L 279

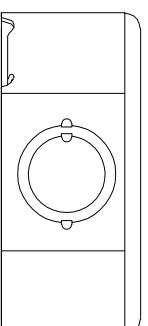
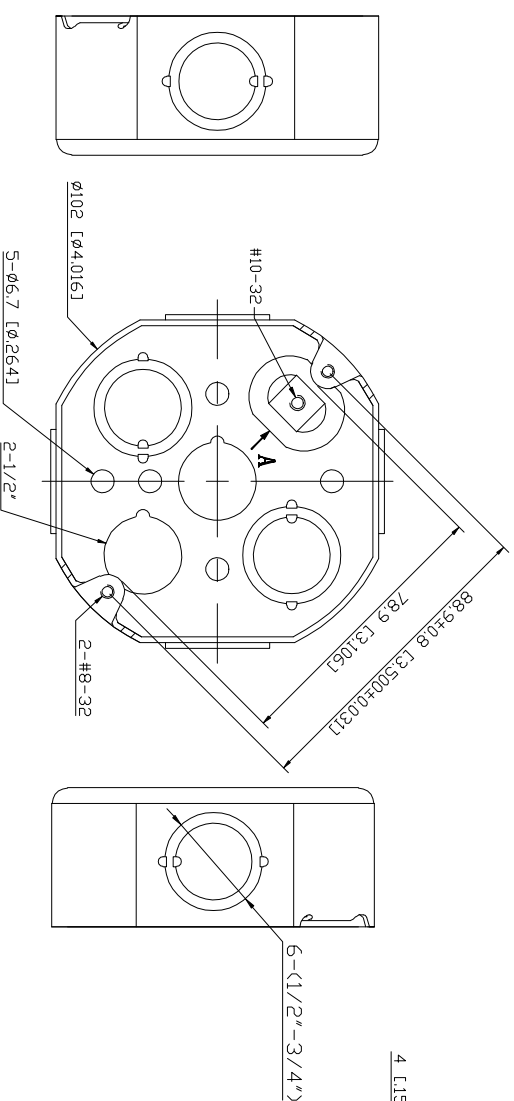
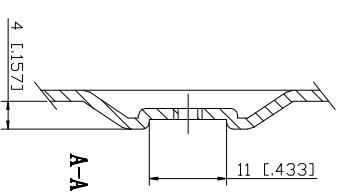
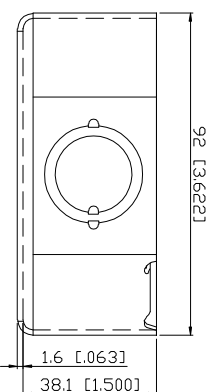
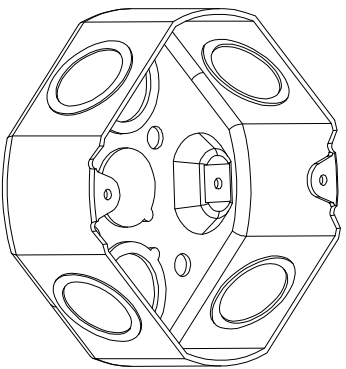

4×4×1-1/2"  
 (4" B-1/2" & 3/4")  
 1.6mm