

ELECTROLINE

Cat.# E-L 288

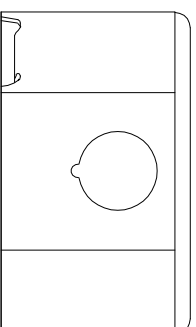
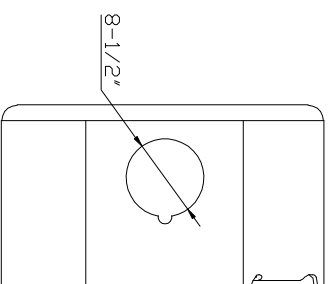
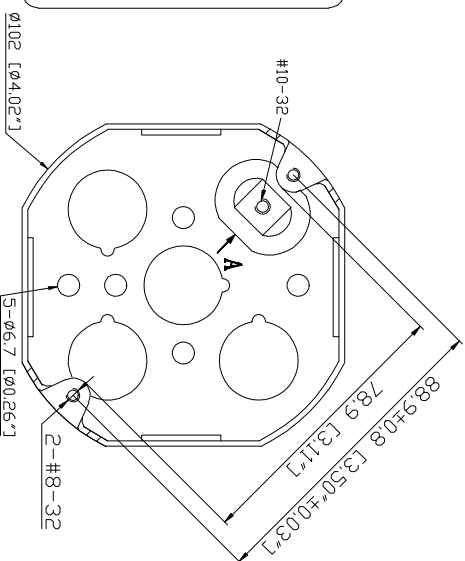
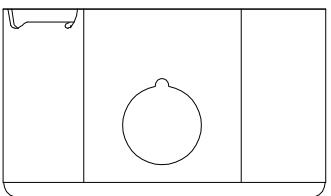
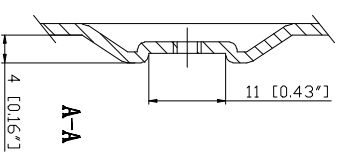
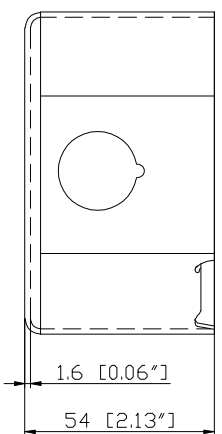
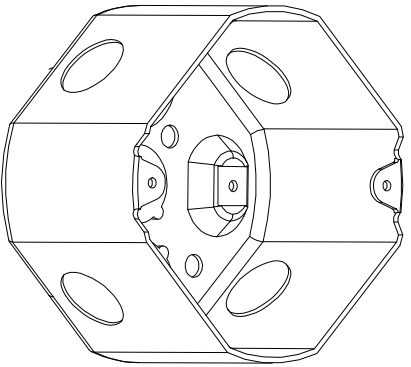

4×4×2-1/8"
(4"B-1/2")

1.6mm