

# ELECTROLINE

## Cat.# E-L 292

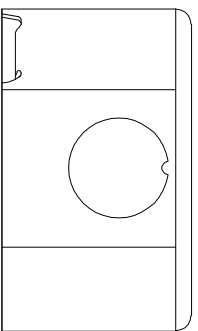

4×4×2-1/8"  
(4"B-1/2" & 3/4")  
1.6mm

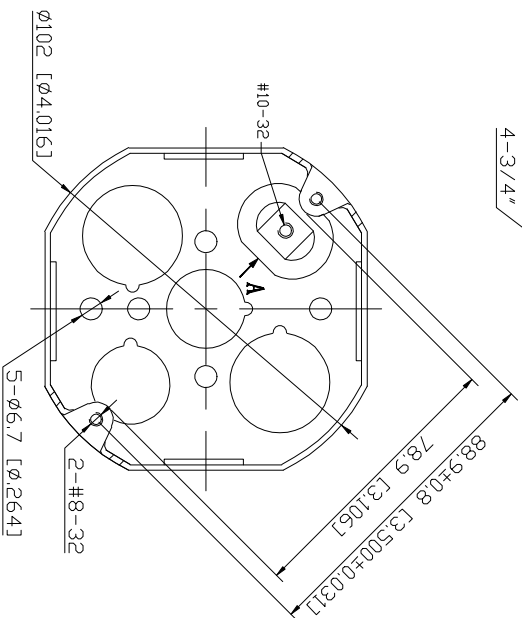
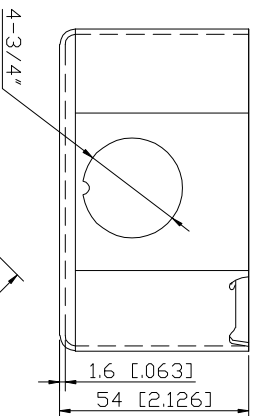
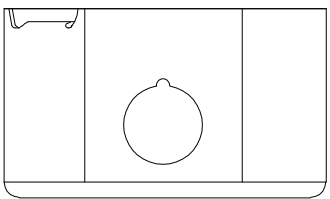
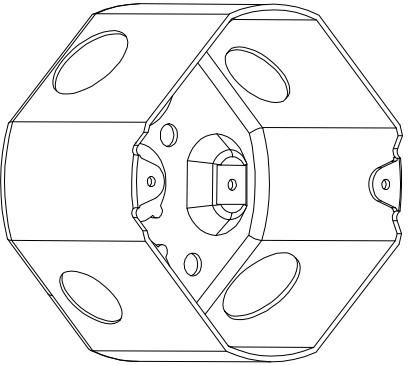