

# ELECTROLINE

## Cat.# E-L 414

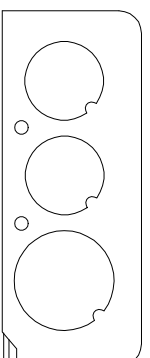
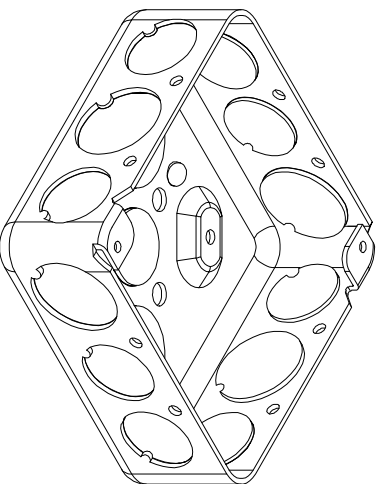
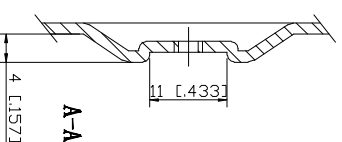
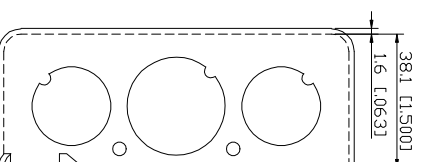
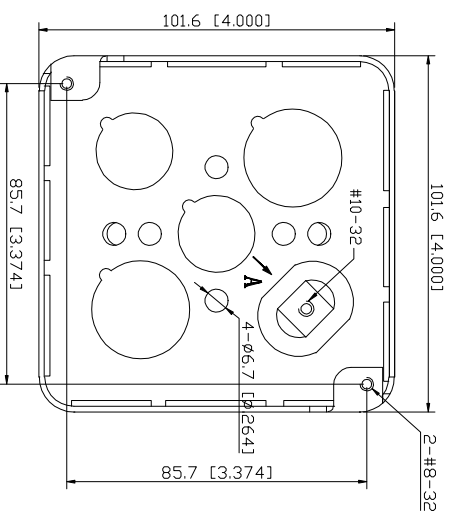
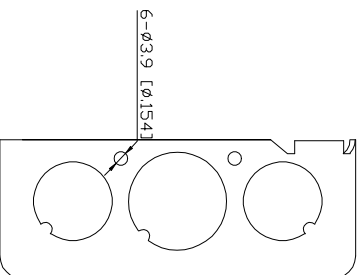
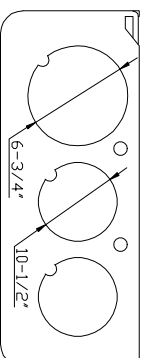

4x4x1-1/2"  
 (4" A-1/2" & 3/4")  
 1.6mm